

Article number: 201138835

Description: E+G stainless steel-ball lock pin  
GN 113.8-8-35

## Measures

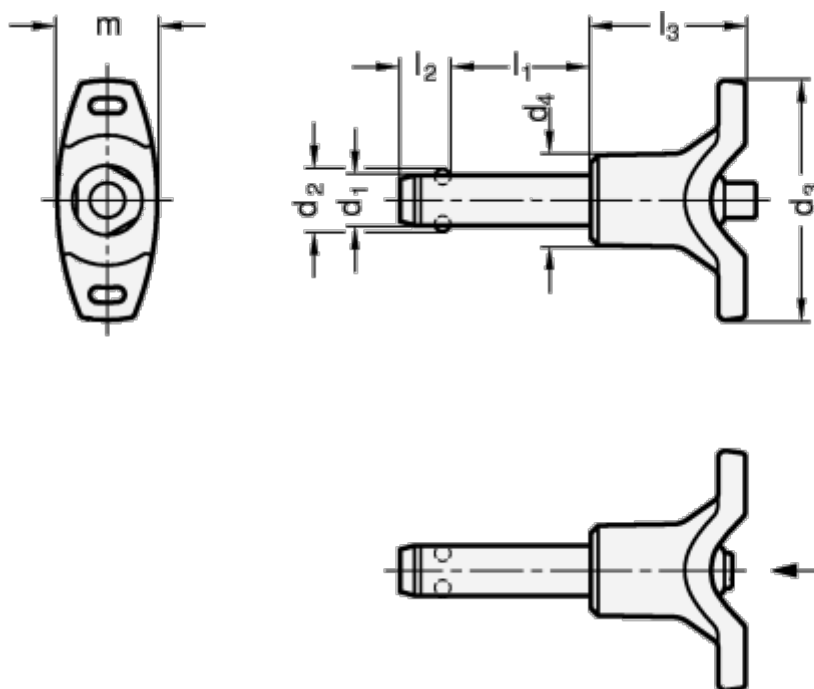

d1 = 8

d2 = 9.5

d3 = 48

d4 = 18.0

l1 = 35

l2 = 8.2

l3 = 31.0

m = 20.5

Resilience (N) = 63